

REVISIONS		
ISS	ZONE	DESCRIPTION\PER REQUEST\DATE

SALES

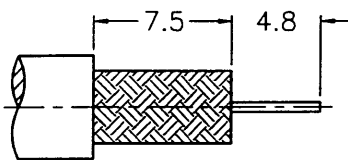

RECOMMENDED
CABLE STRIPPING DIM'S
(STEP 1)
(建議剝線尺寸 步驟一)

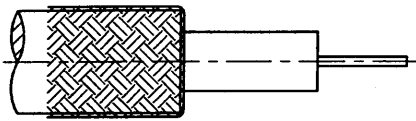

(STEP 2)
(步驟二)

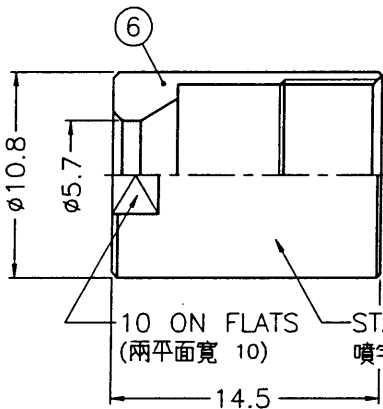

10 ON FLATS (兩平面寬 10) STAMP (IF ANY) 噴字 (若有要求)

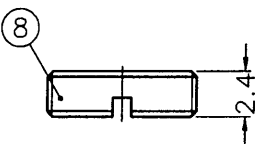
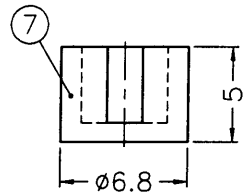
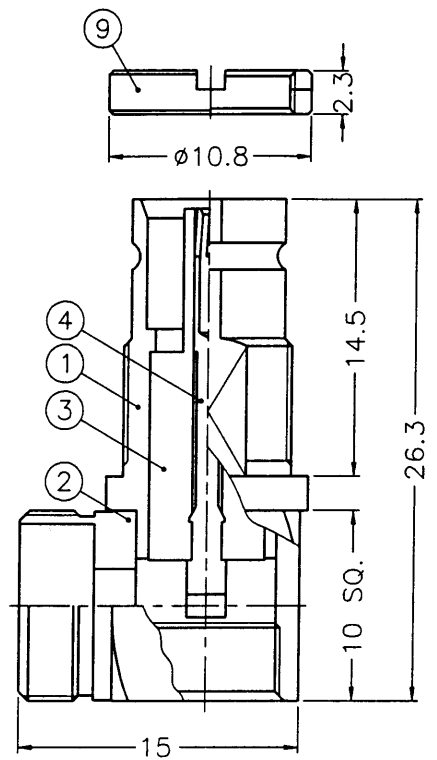
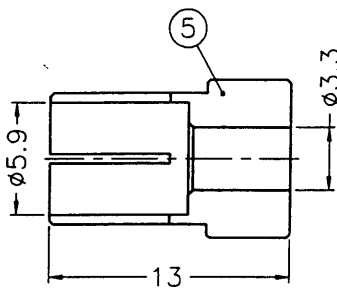

- 1. CONTACT PIN TO SOLDER
- 2. MAX. PANEL THICKNESS=3mm



NOTES: FINISH (PLATING THICKNESS IN MICRO-INCHES)
 1. BRASS PER QQ-B-626
 2. NICKEL PL. 100 MIN. THICK OVER COPPER STRIKE
 3. PHOSPHOR BRONZE PER QQ-B-750
 4. GOLD PL. 3 MIN. THICK OVER NICKEL PL. 100 MIN. THICK OVER COPPER STRIKE
 5. TEFLON MIL-P-19468

NO.	DESCRIPTION	MATERIAL	FINISH	Q'TY	DRAWING NO.
9	NUT	NOTE 1	NOTE 2	1	RN108-9-05X23S
8	NUT	NOTE 1	NOTE 2	1	15687061606-5
7	INSULATOR	DELTRIN	NATURAL	1	15687061606-4
6	NUT	NOTE 1	NOTE 2	1	1566442A1-7-57
5	BRAID CLAMP	NOTE 1	NOTE 2	1	1566442A1-6-59 /33
4	CONTACT PIN	NOTE 3	NOTE 4	1	1566412A1-4-B
3	INSULATOR	NOTE 5	NATURAL	1	1566412A1-3-B
2	HOUSING	NOTE 1	NOTE 2	1	1566442A1-2-39
1	OUT CONTACT	NOTE 1	NOTE 4	1	1566412A1-1

DIMENSIONS ARE IN MILLIMETERS				PART NO.	
UNLESS OTHERWISE SPECIFIED TOLERANCES				APPROVED	DATE
0.5-6 = ±0.2				<i>gacku</i>	07-23-01'
6-30 = ±0.4				CHECKED	DATE
30-120 = ±0.6				<i>gacku</i>	07-23-01'
120-315 = ±1				DRAWN	DATE
315-1000 = ±1.6				<i>Ada</i>	07-23-01'
1000-2000 = ±2.4				SCALE 2.5/1 ISSUE A	

Amphenol - Kai Jack	
TAINAN TAIWAN	
TITLE	1.6/5.6 R/A CLAMP JACK (FOR PACIFIC 3C-2V CABLE)
DRAWING NO.	KJ-1566442A1-N/3GT3G-3C2V-75
FILE NO.	F:\DWG\156\6442A1\3C2V-75\N3GT3G

F
E
D
C
B
A

F
E
D
C
B
A