

1	2	3	4	5	6	7	8
REVISIONS		DESCRIPTION \ PER REQUEST \ DATE					
ISS	ZONE						

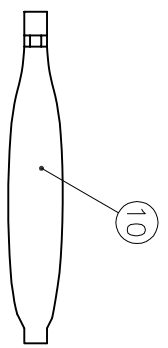
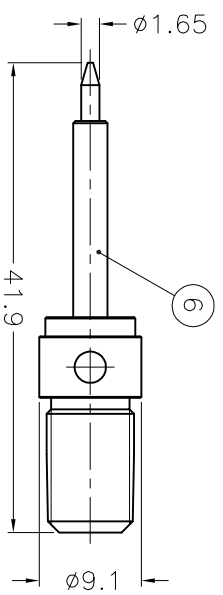
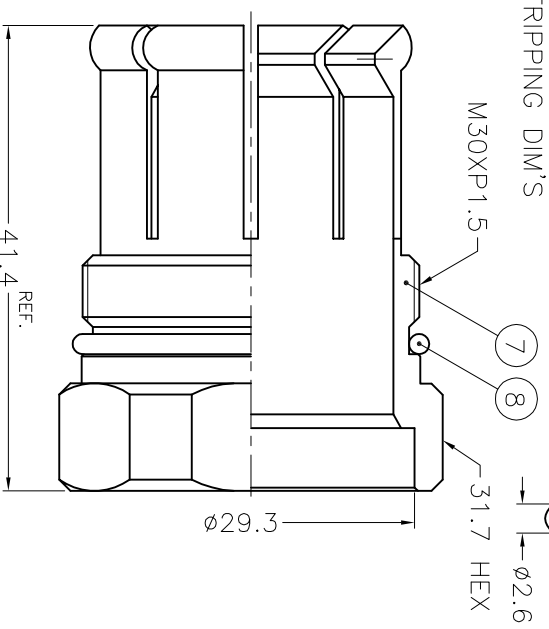
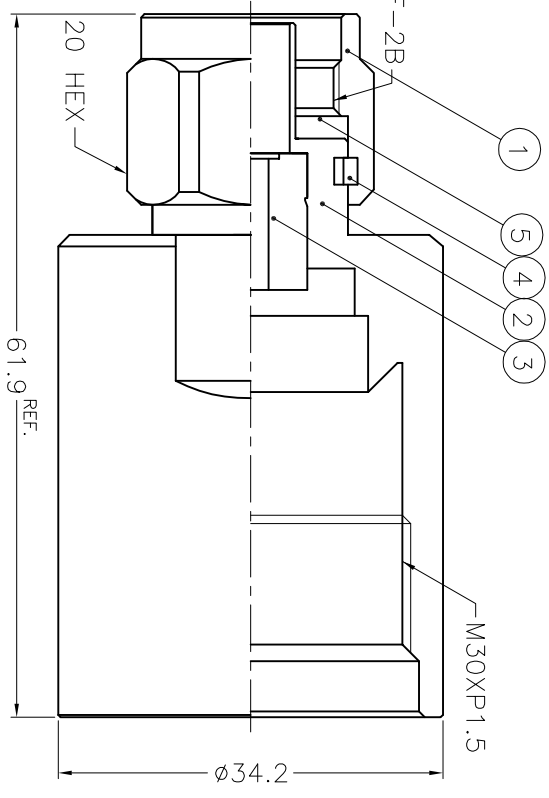
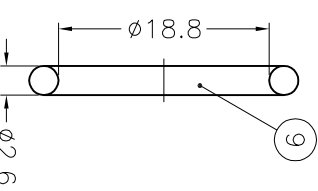
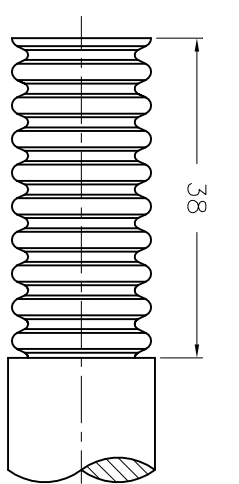
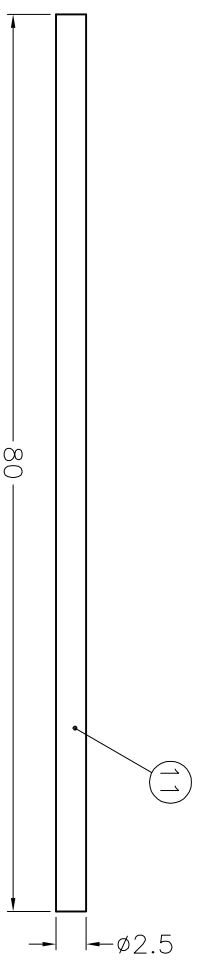

NOTES: FINISH (PLATING THICKNESS IN MICRO-INCHES)  
 1: BRASS PER QQ-B-626  
 2: ALBALOY PLATING (COPPER-TIN-ZINC)  
 3: SILVER PL. 200 MIN. THICK OVER COPPER STRIKE  
 4: TEFLON ML-P-19468  
 5: NICKEL PL. 100 MIN. THICK OVER COPPER STRIKE  
 6: SILICONE GREASE PER POLYTEX 55-M OR EQUIVALENT

11	TOOL BAR	S45C	NOTE 5	1	N87070303-11
10	LUBRICATOR	NOTE 6	NOTE 6	1	N87070302-11
9	GASKET	SILICONE	RED	1	GS-24/188XD26
8	GASKET	SILICONE	RED	1	GS-304/27XD17
7	NUT	NOTE 1	NOTE 2	1	N87070303-7
6	CONTACT PIN	NOTE 1	NOTE 3	1	N87070303-6
5	GASKET	SILICONE	RED	1	GS-156/8X15
4	RETAINER RING	SUS 304	NATURAL	1	N5000-7-C
3	INSULATOR	NOTE 4	NATURAL	1	N87070303-3
2	BODY	NOTE 1	NOTE 2	1	N87070303-2
1	SHELL	NOTE 1	NOTE 2	1	N5000-1H
NO.	DESCRIPTION	MATERIAL	FINISH	Q'TY	DRAWING NO.

DIMENSIONS ARE IN MILLIMETERS  
 UNLESS OTHERWISE SPECIFIED  
 TOLERANCES  
 0.5-6 = ±0.2  
 6-30 = ±0.4  
 30-120 = ±0.6  
 120-315 = ±1  
 315-1000 = ±1.6  
 1000-2000 = ±2.4

PART NO.	DATE
APPROVED	10-12-00'
CHECKED	10-12-00'
DRAWN	10-12-00'

**Amphenol - Kai Jack**  
 TAINAN TAIWAN

TITLE  
 N PLUG  
 (FOR ANDREW 7/8" LDF5-50A HELIAX CABLE)

DRAWING NO.  
 KJ-N1141G1-N/NTS-7/8A-50  
 FILE NO. F:\DWG\N\1141G1\78A\NNTS

A

B

C

D

E

F

A

B

C

D

E

F