

REVISIONS		
ISS	ZONE	DESCRIPTION\PER REQUEST\DATE

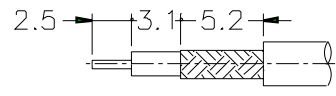

RECOMMENDED  
CABLE STRIPPING DIM'S  
(建議剝線尺寸)

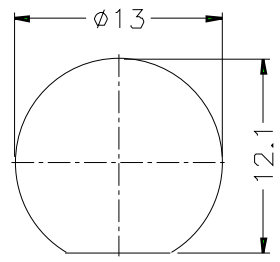

RECOMMENDED  
MOUNTING HOLE  
(建議架設孔)

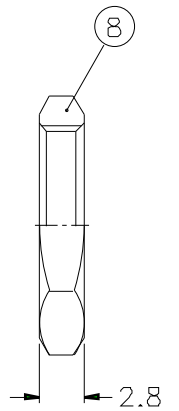
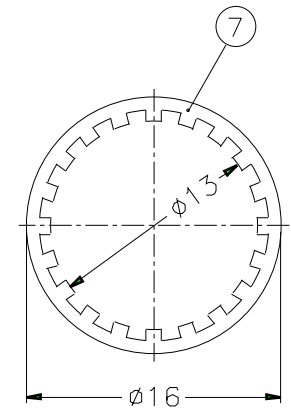
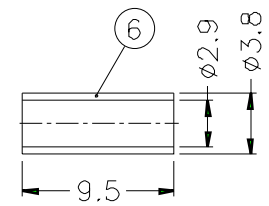
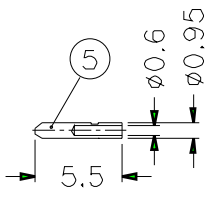
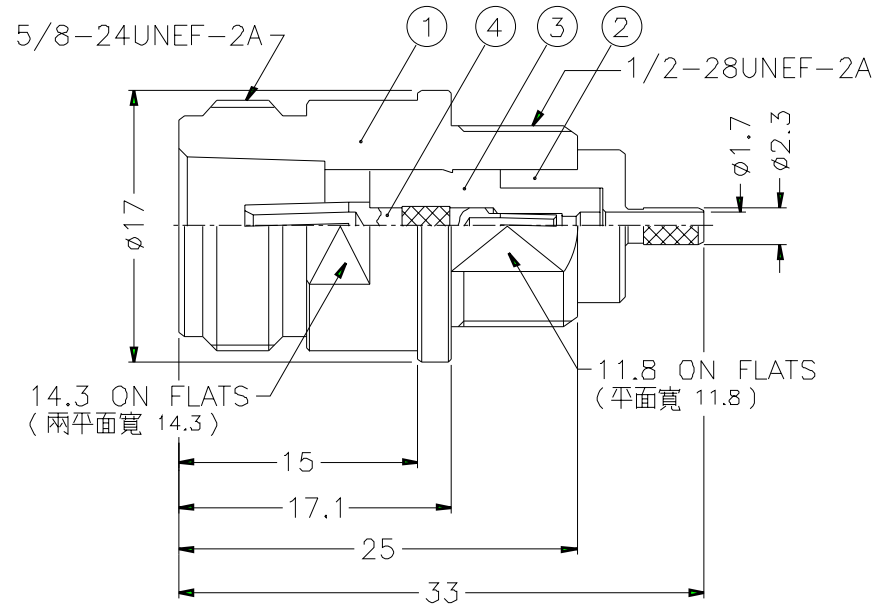

NOTES: FINISH (PLATING THICKNESS IN MICRO-INCHES)

- BRASS PER QQ-B-626
- BRASS PER QQ-B-613
- NICKEL PL. 100 MIN. THICK OVER COPPER STRIKE
- PHOSPHOR BRONZE PER QQ-B-750
- GOLD PL. 3 MIN. THICK OVER NICKEL PL. 100 MIN. THICK OVER COPPER STRIKE
- TEFLON MIL-P-19468

- CRIMPED FERRULE  
HEX. CRIMP SIZE .128"
- CRIMPED CONTACT PIN  
SQ. CRIMP SIZE 0.7mm
- MAX. PANEL THICKNESS=3mm

NO.	DESCRIPTION	MATERIAL	FINISH	Q'TY	DRAWING NO.
8	HEX NUT	NOTE 1	NOTE 3	1	HN14-1/2-28X28
7	LOCK WASHER	NOTE 2	NOTE 3	1	LW-16/13X05
6	FERRULE	COPPER	NOTE 3	1	FR00AAE37A
5	CONTACT PIN	NOTE 1	NOTE 5	1	B50003-9-0.6
4	CONTACT PIN	NOTE 4	NOTE 5	1	CPO3AFT01A
3	INSULATOR	NOTE 6	NATURAL	1	NS00ATQ01A
2	BARREL	NOTE 1	NOTE 3	1	BR00AKB01A
1	BODY	NOTE 1	NOTE 3	1	BDO3AFB01A

DIMENSIONS ARE IN MILLIMETERS			
UNLESS OTHERWISE SPECIFIED TOLERANCES			
0.5-6	= ±0.2		
6-30	= ±0.4		
30-120	= ±0.6		
120-315	= ±1		
315-1000	= ±1.6		
1000-2000	= ±2.4		
SCALE	2/1	ISSUE	1

PART NO.	
APPROVED	DATE 04-10-02'
CHECKED	DATE 04-10-02'
DRAWN	DATE 04-10-02'
FILE NO.	F:\DWG\N\6321G3\316U-50\NT3G

<b>Amphenol - Kai Jack</b>	
TAINAN TAIWAN	
TITLE	N FRONT BULKHEAD CRIMP JACK (FOR RG-174/U,188A/U,316/U)
DRAWING NO.	KJ-N6321G3-NT3G-316U-50
ITEM NO.	036321AAA36NA5F