

ISS	ZONE	DESCRIPTION\PER REQUEST\DATE

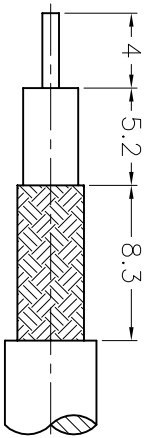

RECOMMENDED  
CABLE STRIPPING DIM'S  
(建議剝線尺寸)

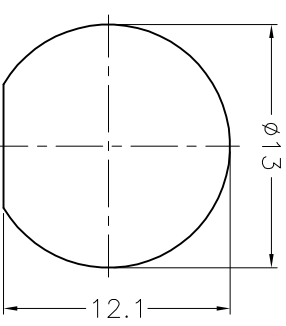

RECOMMENDED  
MOUNTING HOLE  
(建議架設孔)

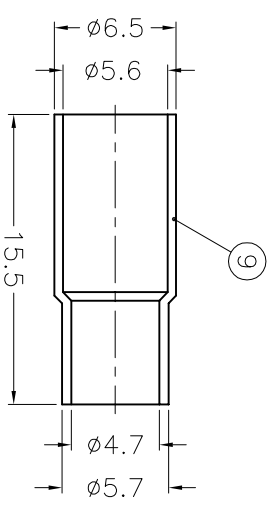
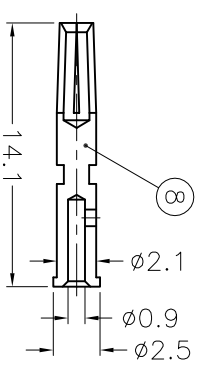
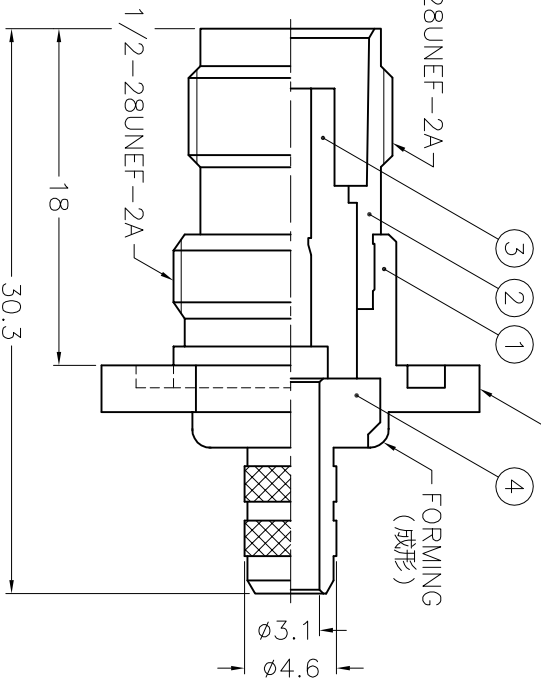
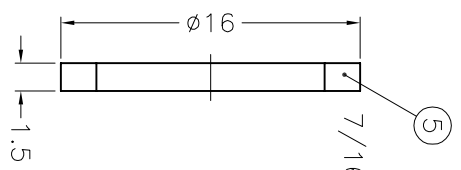
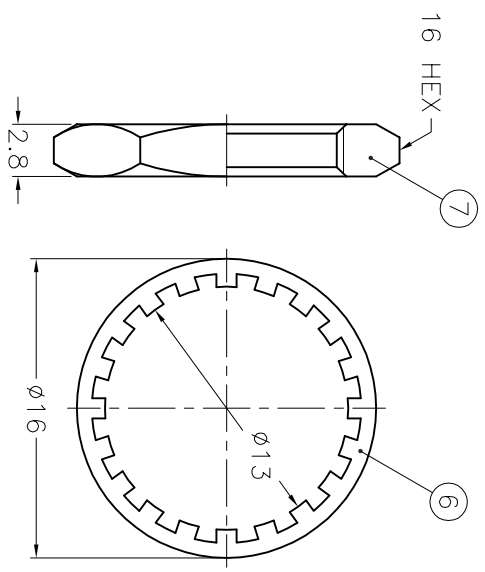

1. CRIMPED FERRULE  
HEX CRIMP SIZE ".213"  
2. CRIMPED CONTACT PIN  
HEX CRIMP SIZE ".068"

NOTES: FINISH (PLATING THICKNESS IN MICRO-INCHES)

1. BRASS PER QQ-B-626
2. BRASS PER QQ-B-613
3. NICKEL PL. 100 MIN. THICK OVER COPPER STRIKE
4. PHOSPHOR BRONZE PER QQ-B-750
5. GOLD PL. 3 MIN. THICK OVER NICKEL PL. 100 MIN. THICK OVER COPPER STRIKE
6. JIS H 3260, C 3501

NO.	DESCRIPTION	MATERIAL	FINISH	Q'TY	DRAWING NO.
1	HOUSING	NOTE 1	NOTE 3	1	B74000-1
2	BODY	NOTE 1	NOTE 3	1	T74000-2
3	INSULATOR	DELRIIN	NATURAL	1	B74050-3-50-B
4	BARREL	NOTE 1	NOTE 3	1	B74000-4-46/31
5	GASKET	RUBBER	RED	1	GS-16/122X15
6	LOCK WASHER	NOTE 2	NOTE 3	1	LW-16/13X05
7	HEX NUT	NOTE 1	NOTE 3	1	HN16-1/2-28X28
8	CONTACT PIN	NOTE 4	NOTE 5	1	B74000-8-25/09
9	FERRULE	NOTE 6	NOTE 3	1	FR-65/56-57/47 X155

DIMENSIONS ARE IN MILLIMETERS  
UNLESS OTHERWISE SPECIFIED  
TOLERANCES

0.5-6 = ±0.2  
6-30 = ±0.4  
30-120 = ±0.6  
120-315 = ±1  
315-1000 = ±1.6  
1000-2000 = ±2.4

PART NO.  
APPROVED  
CHECKED  
DRAWN

TITLE  
TNC BULKHEAD CRIMP JACK  
DRAWING NO.  
KJ-T6421D1-ND3G-58T-50

SCALE 2.5/1 ISSUE A  
DATE 12-08-99'  
DATE 12-08-99'  
DATE 12-08-99'  
shaly  
FILE NO. F:\DWG\T\6421D1\58T-50\ND3G

**Amphenol - Kai Jack**  
TAINAN TAIWAN